

Novo

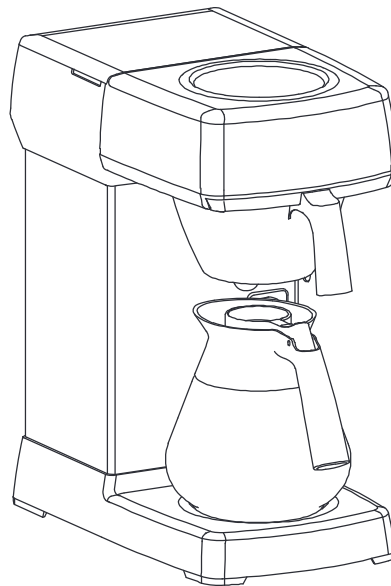

User manual
Mode d'emploi Utilisateur
Gebraucher Handbuch
Gebruiksaanwijzing
Användarmanualen
Brukerhåndbok
Brugsanvisningen
Käyttäjän käsikirja
Manual del usuario
Manual do utilizador
Manuale per l'utente
Εγχειρίδιο χρήσης
Prostudujte uživatelskou
Podręcznik użytkownika
Manualul utilizatorului
Руководство пользователя
Kullanıcı kılavuzu
使用者手冊
ユーザーマニュアル
사용자 설명서

Model nr.: • NOVO-0xx



English
Français
Deutsch
Nederlands
Svenska



Norsk
Dansk
Suomi
Español
Português

Italiano
Ελληνικά
Česky
Polski
Română



Русский
Türkçe
Հայերեն
한국어

Information Information Information Informatie Information		Informasjon Information Informaatio Información Informação
Installation Installation Installation Installieren Installation		Installasjon Installation Asennus Instalar Instalação
Handling Fonctionnement Bedienung Bedienen Handhavande		Betjene Betjening Käsittely Operación Execução
Cleaning Nettoyage Reinigung Schoonmaken Rengöring		Vasking Rengøring Puhdistus Limpiar Limpeza
Descaling Détartrage Entkalkung Ontkalken Avkalkning		Rensing Afkalkning Kalkinpoisto Descalcificación Descalcificação
Safety book Sommaire des sécurités Sicherheitsvorschriften Veiligheidsboek Säkerhetsföreskrifter	 700 403 347	Sikkerhetsbok Sikkerhedsbog Turvallisuusohjeet Libro de seguridad Instruções de segurança
Accessories Accessoires Zubehör Toebehoren Tillbehör		Tilbehør Valgbar Lisälaitteet Accesorios Acessórios
Wait Patienter Warten Wachten Vänta		Vent Vent Odota Esperar Aguardar
Rinse Rinçer Spülen Afspoelen Sköljning		Skylle Rensning Huuhtelee Aclarar Enxaguamento
Safety gloves Gants de sécurité Schutzhandschuh Veiligheidshandschoenen Skydds handskar		Hansker Sikkerheds handsker Suojahanskat Zapatos de seguridad Luvas de protecção
Safety goggles Lunettes de sécurité Schutzbrille Veiligheidsbril Skydds glasögon		Vernebriller Sikkerhedsbriller Suojalasit Gafas de seguridad Óculos de protecção
Dishwasher proof Lave-vaisselle autorisé Geschirrspülertauglich Vaatwasmaschine bestendig Tål maskindisk		Tåler oppvaskmaskin Maskinopvaske bestandig Astianpesukoneen kestävä Rest. para lavaplatos À prova de máquina de lavar louça
Moist cloth Chiffon humide Feuchtes Tuch Vochtige doek Fuktig trasa		Fuktig klut Fugtig klud Kosteä pyyhe Trapo húmedo Pano húmido

Informazione Πληροφορίες Informace Informacja Informație		Информация Bilgi 資料 情報 알림
Installazione Εγκατάσταση Instalace Instalacja Operare		Установка Yerleştirme 安裝 設置 설치
Istruzione d'uso Χειρισμός Obsluha Instrukcja obsługi Instalare		Обслуживание Kullanım 操作 取り扱い 취급
Pulizia Καθαρισμός Čištění Czyszczenie Curățare		Чистка Temizleme 清洗 洗淨 청소
Decalcificazione Αφαλάτωση Odvápnění Odkamienianie Decalcarizare		Чистка от накипи Kireçten arındırma 除垢 デスケール 스케일 청소
Prescrizioni di sicurezza Εντυπο ασφαλείας Bezpečnostní kniha Wskazówki bezpieczeństwa Carte instructaj	 700 403 347	Инструкция по эксплуатации Güvenlik kitabı 安全冊子 安全説明書 안전 지침서
Accessori Εξαρτήματα Příslušenství Akcesoria Acesorii		Аксессуары Aksesuarlar 附件 備品 약세서리
Attendere Αναμονή Čekejte Czekaj Așteaptă		Ждите Bekle 等候 待つ 기다림
Lavaggio Ελαφριά πλύση Vypláchnout Plukanie Clătire		Прополоскать Durula 沖洗 すすぐ 세척
Guanti di protezione Γάντια ασφαλείας Ochranné rukavice Rękawiczki ochronne Mănuși protecție		Защитные перчатки Güvenlik eldivenleri Ochranné rukavice 安全手套 안전용 장갑
Occhiali di protezione Γυαλιά ασφαλείας Ochranné brýle Okulary ochronne Ochelari protecție		Защитные очки Güvenlik gözlükleri 護目鏡 安全眼鏡 안전용 안경
Idoneo per lavastoviglie Εγγυημένο για χρήση σε πλυντήριο πιάτων Myčka –důkaz Mycie w zmywarce dozwolone Spälåtor veselä		Допускается чистка в посудомоечной машине Bulaşık makinası uyumlu 可放於洗碗碟機清洗 食器洗い機で使用可能 접시세척기 사용금지
Panno umido Υγρό πανί Vlhká látka Wilgotna szmatka Cârpă umedă		Влажная салфетка Nemli bez 濕布 濕った布 젖은헝겂

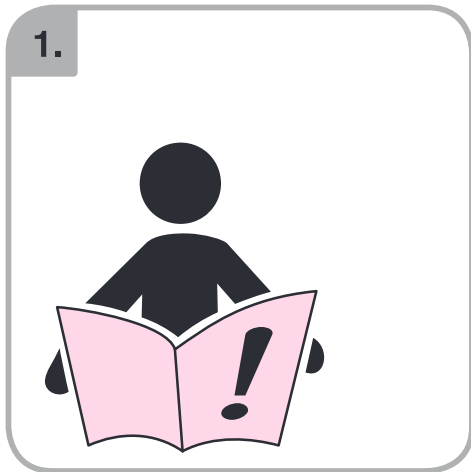

700.403.347

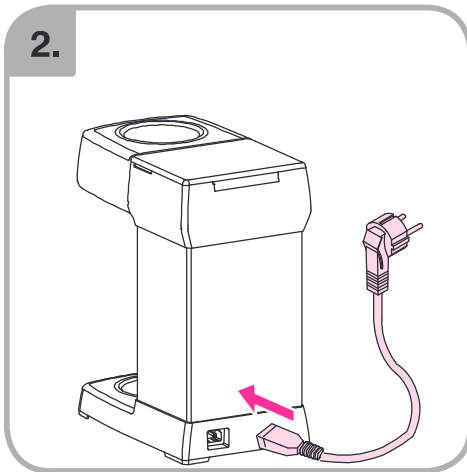

700.403.347

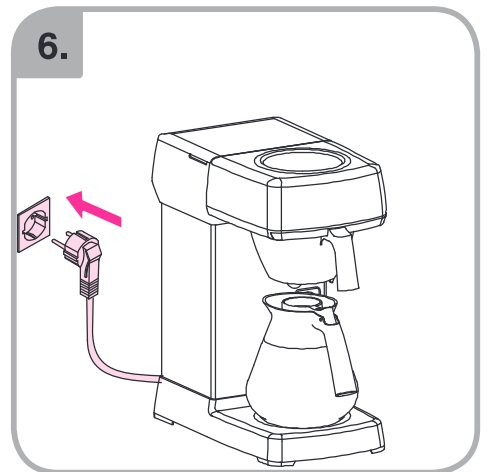
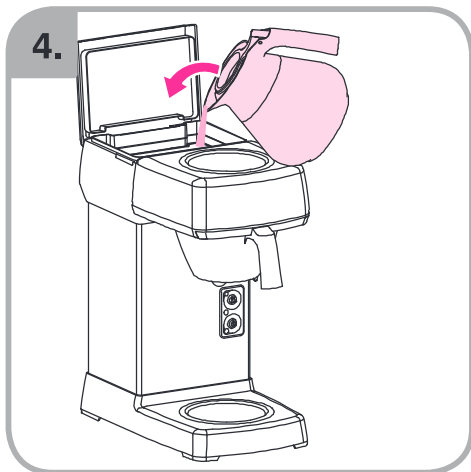

700.403.347

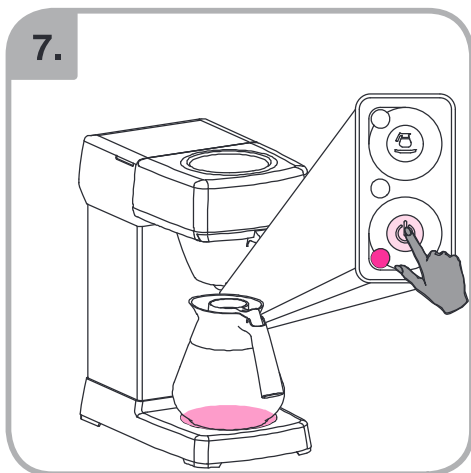

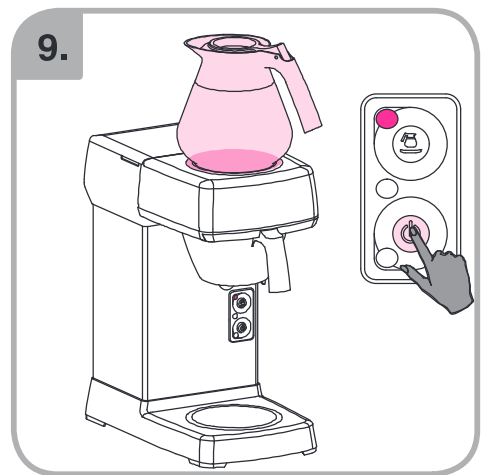
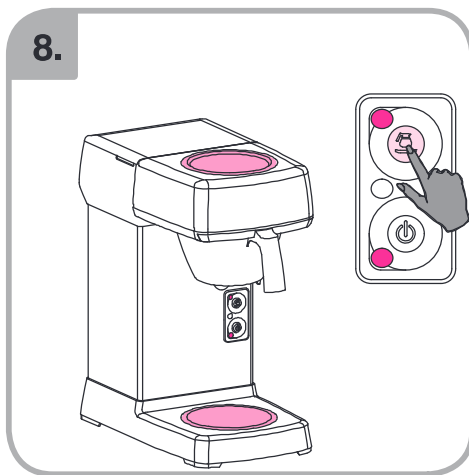
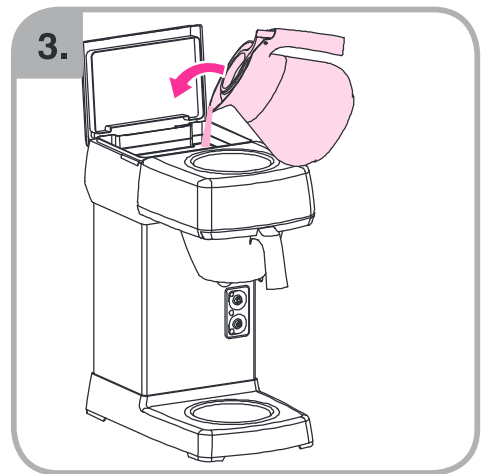
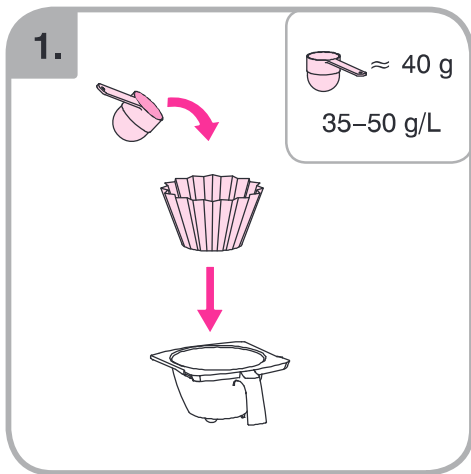

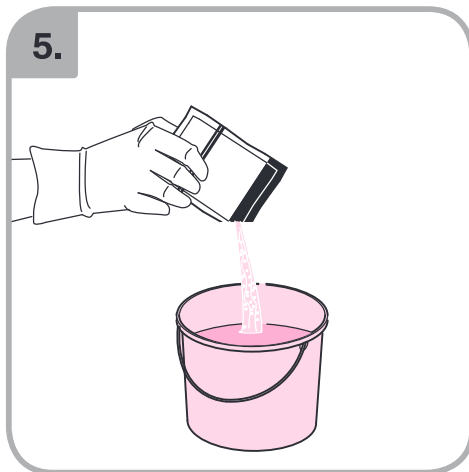
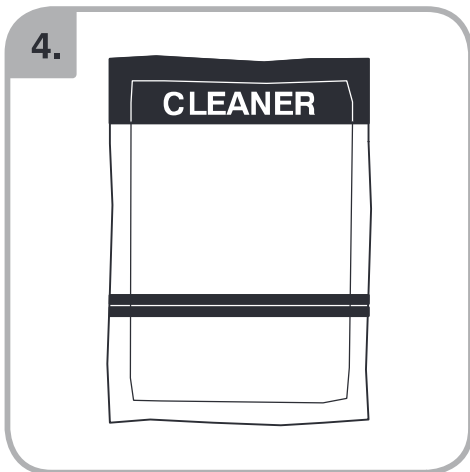

700.403.347

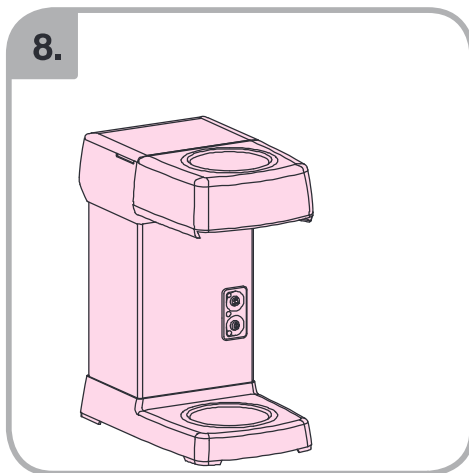
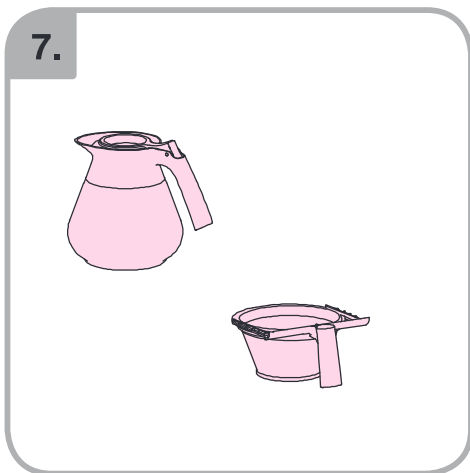



10.



11.

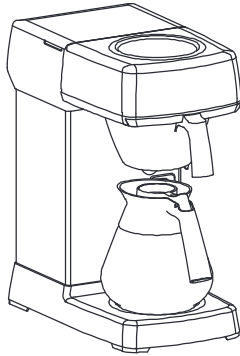



1.

°DH	°TH	250 L	500 L	1000 L	1500 L	2000 L
0- 4	0- 7					
4- 8	7-15					
8-12	15-22					
12-18	22-32					
18-30	32-55					

2.

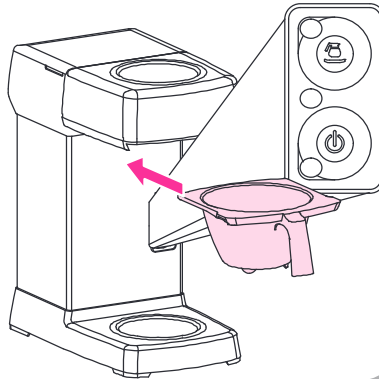

3.

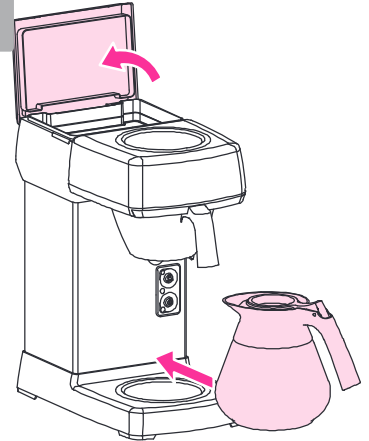

4.

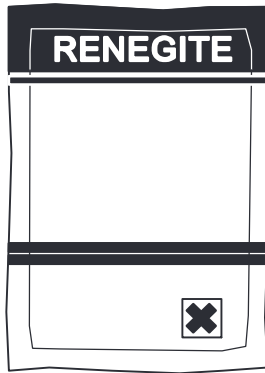

5.



100 g.
0,5 L.
40° C.

6.

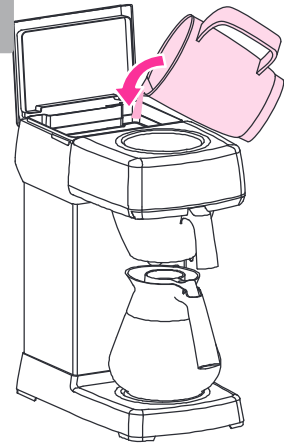

7.



8.



9.



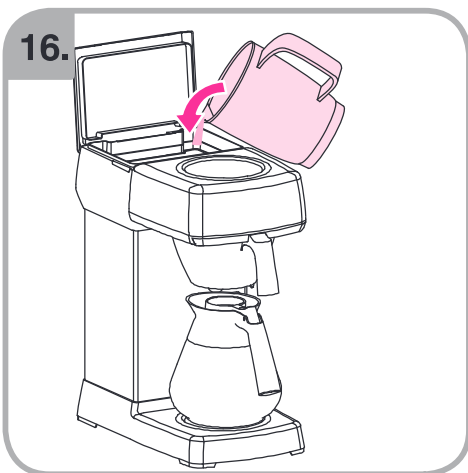
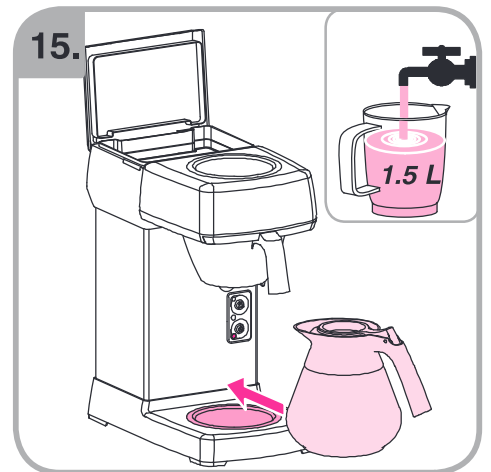
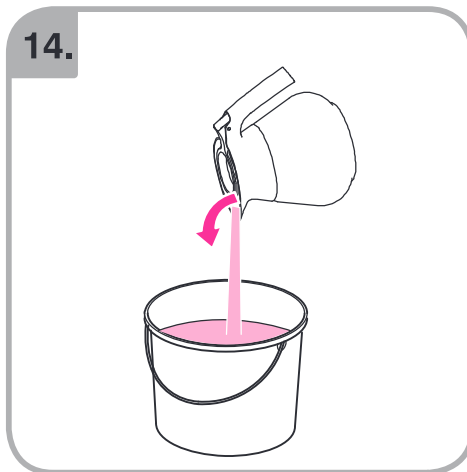



19.

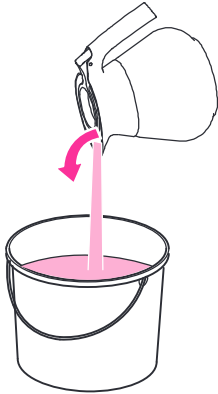

20.

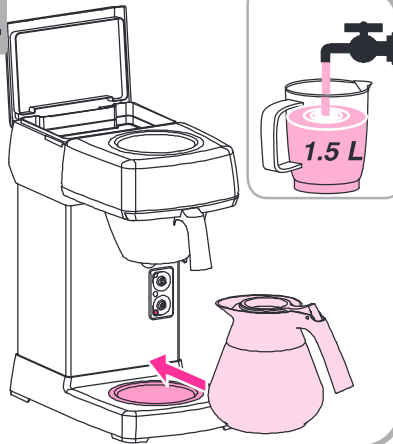

21.

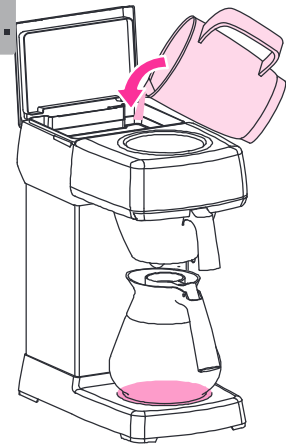

22.



23.

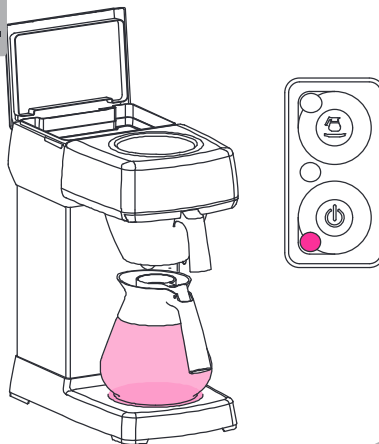

24.

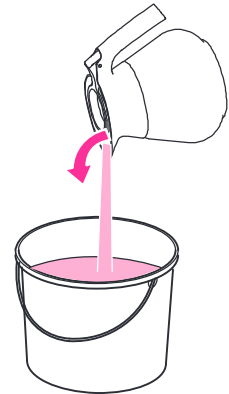

25.

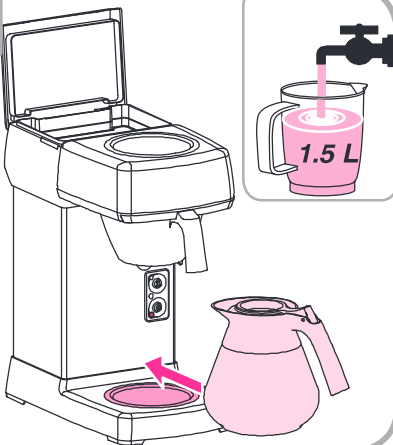

26.

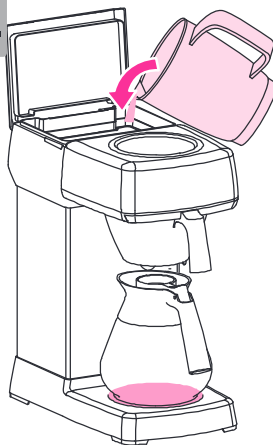

27.

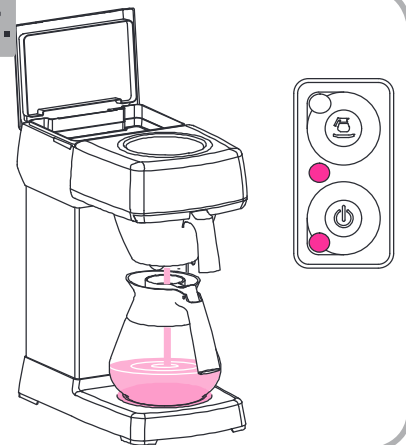



28.

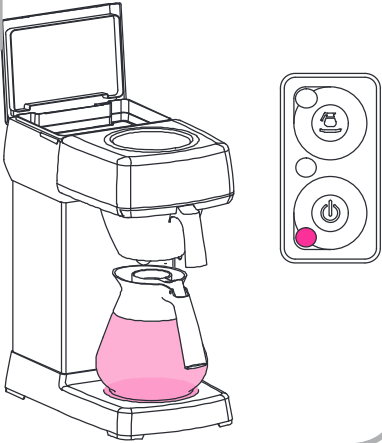

29.



30.

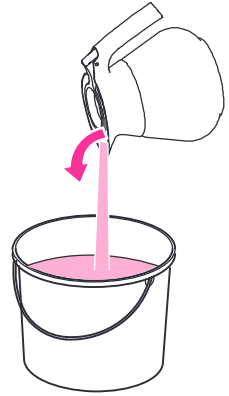

31.

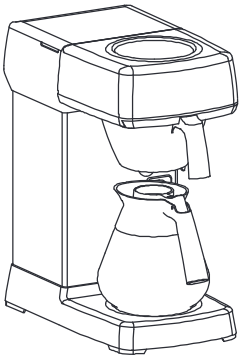



Novo

